

ohne Niveauüberwachung
without float switch

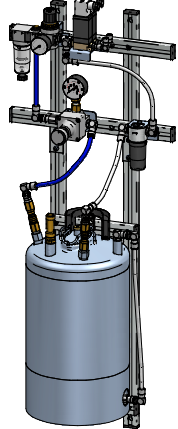

55 00 0300.001
VBG-MDJ10L-01-1Z-2V-024DC

mit Niveauüberwachung
with float switch

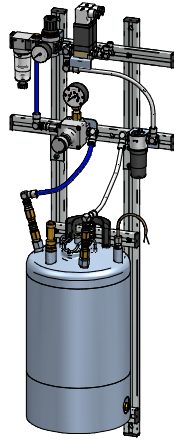

55 00 0300.003
VBG-MDJ10L-01-1Z-2V-024DC-VS

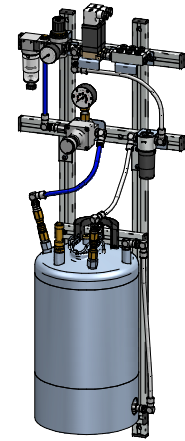

55 00 0301.001
VBG-MDJ10L-03-1Z-2V-024DC

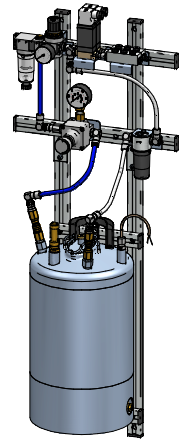

55 00 0301.003
VBG-MDJ10L-03-1Z-2V-024DC-VS

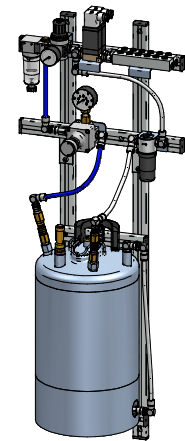

55 00 0302.001
VBG-MDJ10L-06-1Z-2V-024DC

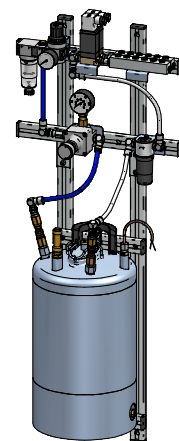

55 00 0302.003
VBG-MDJ10L-06-1Z-2V-024DC-VS

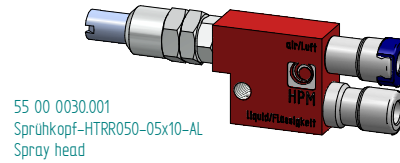

55 00 0030.001
Sprühkopf-HTRR050-05x10-AL
Spray head

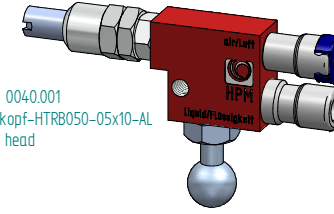

55 00 0040.001
Sprühkopf-HTRB050-05x10-AL
Spray head



55 00 0094.001
Sprühkopf-PSMR-05x10-MS
Spray head

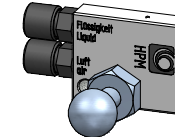

55 00 0096.001
Sprühkopf-PSMB-1fach-05x10-MS
Spray head

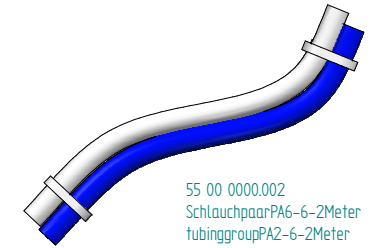

55 00 0000.002
SchlauchpaarPA6-6-2Meter
tubinggroupPA2-6-2Meter
Andere Längen
siehe Ersatzteilblätter
varying lengths
see dimension sheet

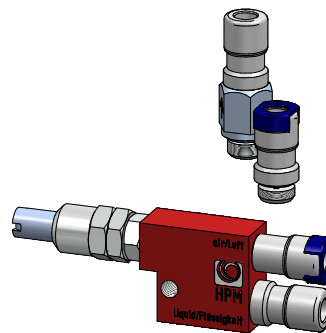

55 00 0031.001
Sprühkopfgruppe-HTRR050-05x10-AL
Spray head group

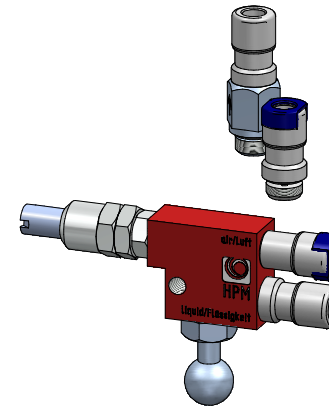

55 00 0041.001
Sprühkopfgruppe-HTRB050-05x10-AL
Spray head group

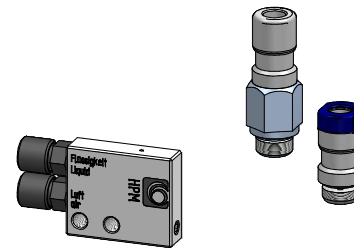

55 00 0095.001
Sprühkopfgruppe-PSMR-05x10-MS
Spray head group

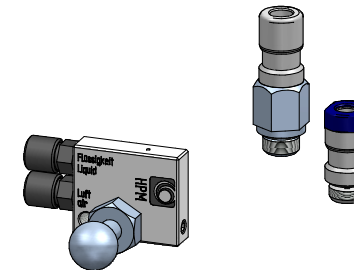

55 00 0097.001
Sprühkopfgruppe-PSMB-05x10-MS
Spray head group



27 77 7000.001
Gelenkarm-F13-3teilig
hinged bracket

27 77 8000.001
Magnetfuss-Arm-F13MH
magnet holder

Index	Titel	Reviz.	N1 der Änderungen		Format
					A 0
1	1				
2	2				
3	3				
4	4				
5	5				
6	6				
7	7				
8	8				
9	9				
10	10				
11	11				
12	12				
13	13				
14	14				
15	15				
16	16				
17	17				
18	18				
19	19				
20	20				
21	21				
22	22				
23	23				
24	24				
25	25				
26	26				
27	27				
28	28				
29	29				
30	30				
31	31				
32	32				
33	33				
34	34				
35	35				
36	36				
37	37				
38	38				
39	39				
40	40				
41	41				
42	42				
43	43				
44	44				
45	45				
46	46				
47	47				
48	48				
49	49				
50	50				
51	51				
52	52				
53	53				
54	54				
55	55				
56	56				
57	57				
58	58				
59	59				
60	60				
61	61				
62	62				
63	63				
64	64				
65	65				
66	66				
67	67				
68	68				
69	69				
70	70				
71	71				
72	72				
73	73				
74	74				
75	75				
76	76				
77	77				
78	78				
79	79				
80	80				
81	81				
82	82				
83	83				
84	84				
85	85				
86	86				
87	87				
88	88				
89	89				
90	90				
91	91				
92	92				
93	93				
94	94				
95	95				
96	96				
97	97				
98	98				
99	99				
100	100				

Alle Angaben ohne Gewähr! Änderungen vorbehalten. Verantwortung für Produktfehler liegt bei dem Anwender. Änderungen vorbehalten. Alle Angaben ohne Gewähr! Änderungen vorbehalten. Verantwortung für Produktfehler liegt bei dem Anwender. Änderungen vorbehalten. Alle Angaben ohne Gewähr! Änderungen vorbehalten. Verantwortung für Produktfehler liegt bei dem Anwender.